

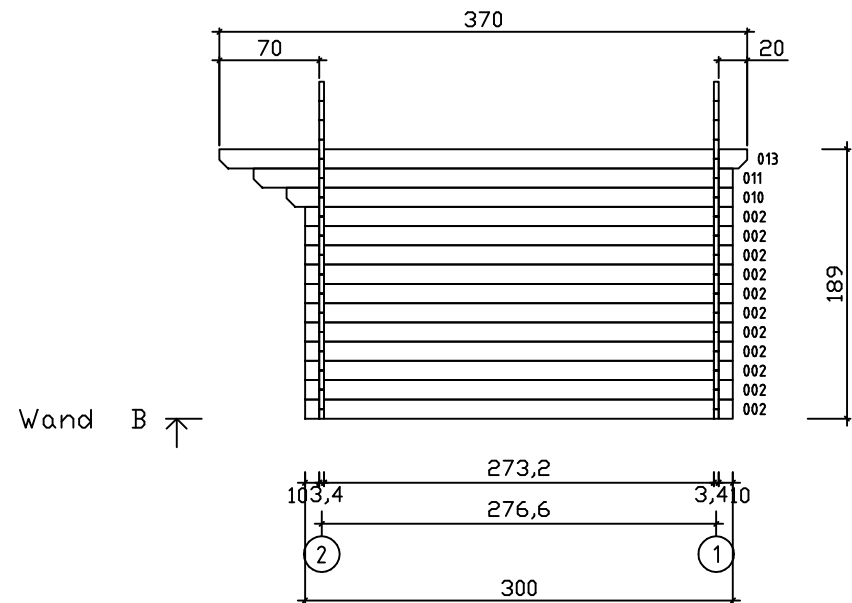

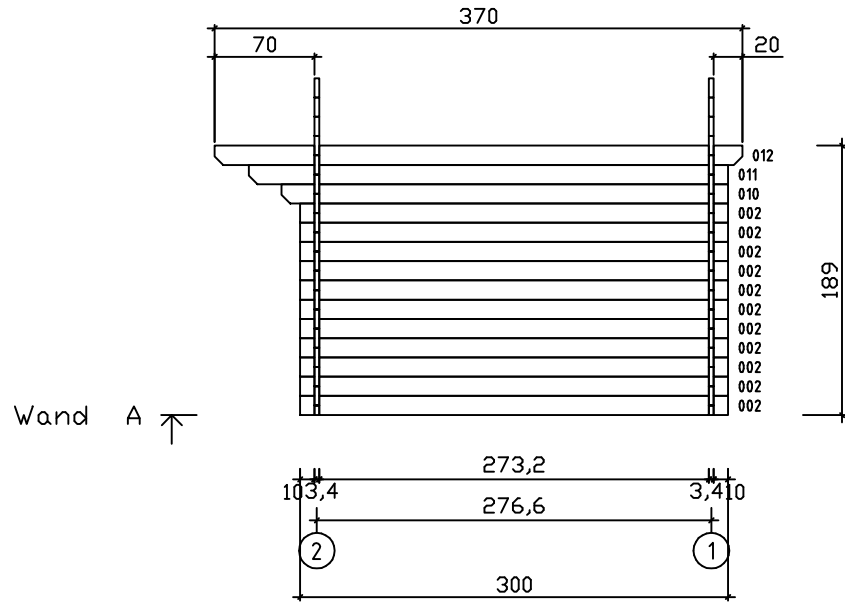

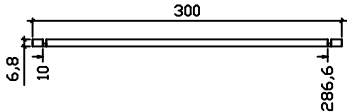

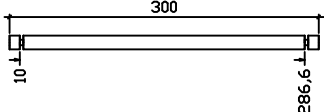

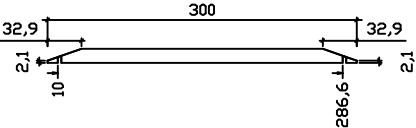
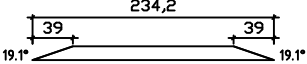
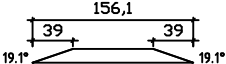
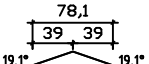
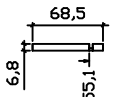

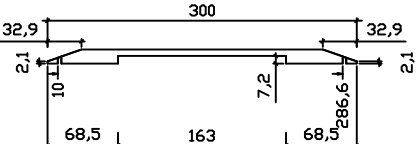
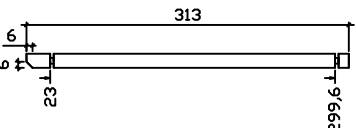

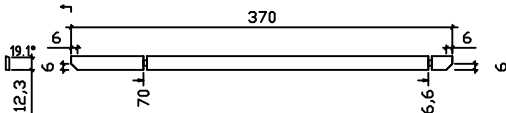
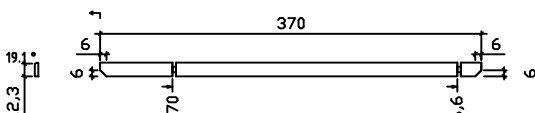
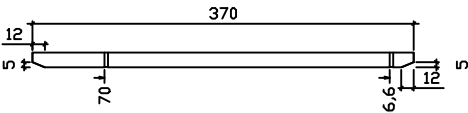
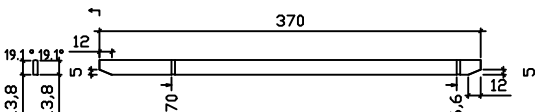

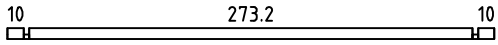
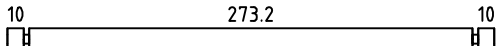
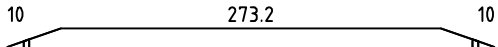
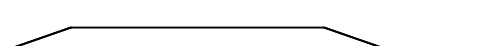
| | |
|---------------------|-----------------------|
| Kood Albacate | Leht 1 |
| Joonis Plaan | Mootkava 1:50 |
| Materjal 3,4 x 13,5 | Kuup. 13.12.2023 |
| Joonestas | File Haus Albacete 34 |

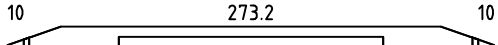
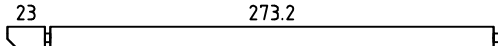
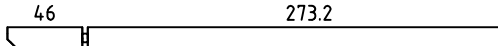
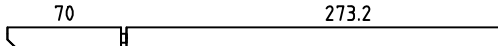
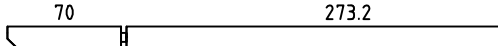
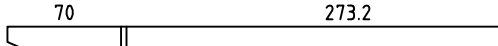
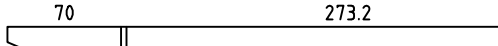
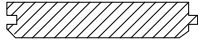

| | | | |
|-----------|-----------------------|----------|------------|
| Kood | Albacate | Leht | 2 |
| Joonis | Wand A | Mootkava | 1:50 |
| Materjal | 3,4x13,5 | Kuup. | 13.12.2023 |
| Joonestas | File Haus Albacete 34 | | |

| | | | |
|---|-------------------|-------------------------|----------|
|  | 001 /1 | | |
|  | 002 /35 | | |
|  | 003 /1 | | |
|  | 004 /2 | | |
|  | 005 /2 | | |
|  | 006 /2 | | |
|  | 007 /2 | | |
|  | 008 /26 | | |
|  | 009 /1 | | |
|  | 010 /2 | | |
| Kood Albacate | Materjal 3.4x13.5 | File Haus Albacete 34mm | Leht 1/3 |

| | | | |
|--|----------------------------|-------------------------|----------|
|  | 011 /2 | | |
|  | 012 /1 | | |
|  | 013 /1 | | |
| PÕHIPÄRLINID | | | |
|  | PR1 /2 4.3x14.5(3.3x14) | | |
|  | PR2 /1 4.3x14.5(3.3x14) | | |
| Kood Albacate | Materjal 3.4x13.5 | File Haus Albacete 34mm | Leht 2/3 |

| Pos | Drawing Albacate | Pcs | Profile (cm) | Length (cm) |
|---------------|---|----------|-----------------|------------------------|
| 001 |  | 1 | 3.4x6.8 | 300 |
| 002 |  | 35 | 3.4x13.5 | 300 |
| 003 |  | 1 | 3.4x13.5 | 300 |
| 004 |  | 2 | 3.4x13.5 | 234.2 |
| 005 |  | 2 | 3.4x13.5 | 156.1 |
| 006 |  | 2 | 3.4x13.5 | 78.1 |
| 007 |  | 2 | 3.4x6.8 | 68.5 |
| 008 |  | 26 | 3.4x13.5 | 68.5 |
| 009 |  | 1 | 3.4x13.5 | 300 |
| 010 |  | 2 | 3.4x13.5 | 313 |
| 011 |  | 2 | 3.4x13.5 | 336 |
| 012 |  | 1 | 3.4x13.5 | 370 |
| 013 |  | 1 | 3.4x13.5 | 370 |
| PR1 |  | 2 | 4.3x14.5 | 370 |
| PR2 |  | 1 | 4.3x14.5 | 370 |
| | DOOR 161x187 | 1 | | |
| 014 | ROOF BOARDS/DACHBRETTER/VOLIGE  | 66 | 11.2x1.6 | 175 |
| 015 | ROOF EDGE REINFORCEMENT/TRAUFENLEISTE/TASSEAU  | 2 | 2.6x3.2 | 370 |
| 016 | ROOF SIDE BOARDS/TRAUFENBRETT/PLANCHE DE RIVE  | 2 | 1.8x6 | 370 |
| 017 | FASCIA BOARD/GIEBELBLENDE/PLANCHE DE RIVE (FACADE)  | 4 | 1.8x12.0 | 185 |
| 018 | FASCIA BOARD/GIEBELBLENDE/PLANCHE DE RIVE (FACADE)  | 4 | 1.8x6.0 | 185 |
| 019 | DIAMOND/RAUTE/DIAMANT  | 2 | 1.8x12 | |
| Kood Albacate | | Materjal | | File Haus Albacete 34m |
| | | | | Leung 1/1 |

