

PREMIUM WOODEN DOUBLE BIN STORE

ASSEMBLY INSTRUCTIONS

Side Wall 2 pcs

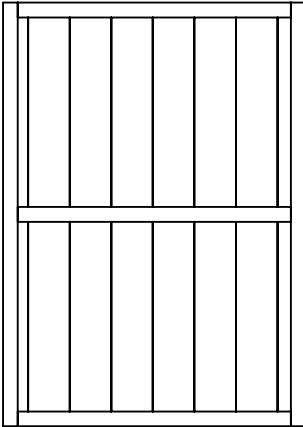

Back Wall 3-pcs

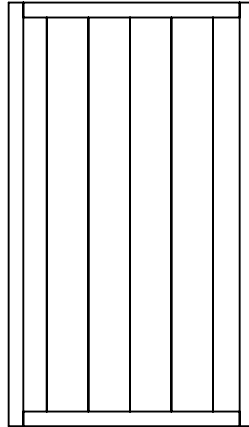

Door 3 pcs

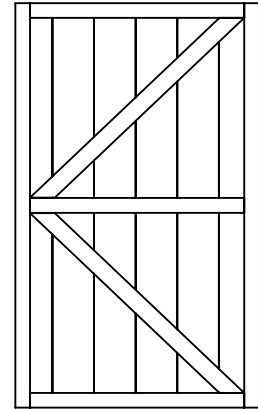

Lid 3pcs

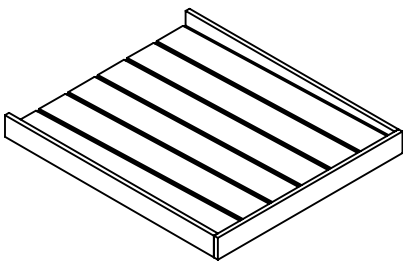

Center Frame 1 8pcs

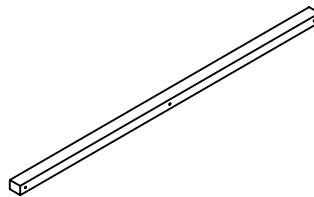

Center Frame 2 12pcs

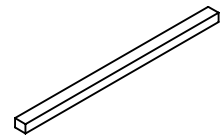

Front Rail 3pcs

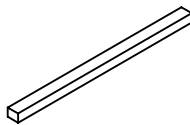

Handle 3pcs



Chain 3pcs



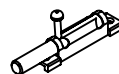

Tower Bolt 3pcs





Hinge 12pcs





 70mm screws
24 pcs

 30mm screws
36 pcs

 60mm screws
24 pcs

 20mm screws
66 pcs

 50 mm screws
20 pcs

 25 mm screws
12 pcs

Recommended Tools For Assembly



3mm drill bit



Before assembly

- We recommend that time is taken to read the instructions before starting assembly, then follow the easy step by step guide. The instruction sheet is only a guide to the assembly. Certain items may not be shown to scale.
- Check all components prior to assembly
- This product should be assembled by no less than two people.
- Never attempt to erect the assembly in high winds.
- Drill all components where indicated.

1. Middle Frame

Connect the 2 no of the vertical frames and the 3 no of the horizontal frames as shown below using 6 x 70mm screws. Repeat this procedure to connect three other middle frames on the same way.

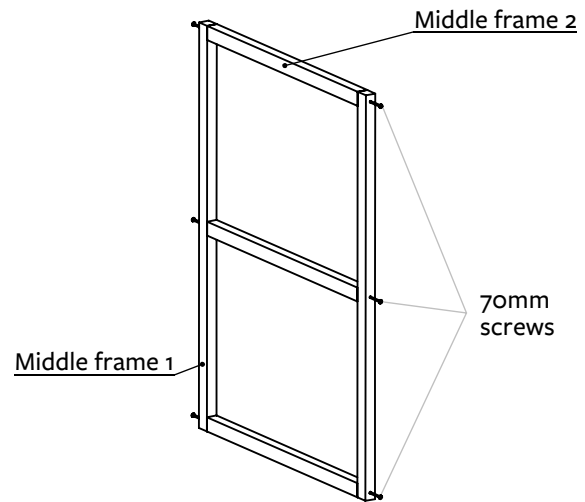

2. Side Panels and Center Section

Secure one of the back wall panel between the one of the side wall panel and the middle frame using 6 x 60mm screws. Attach the door header rail between the side wall panel and the middle frame using 2 x 60mm screws. Repeat this procedure to connect the right hand wall section. In center section connect the back wall and the door header rail between the two middle frames.

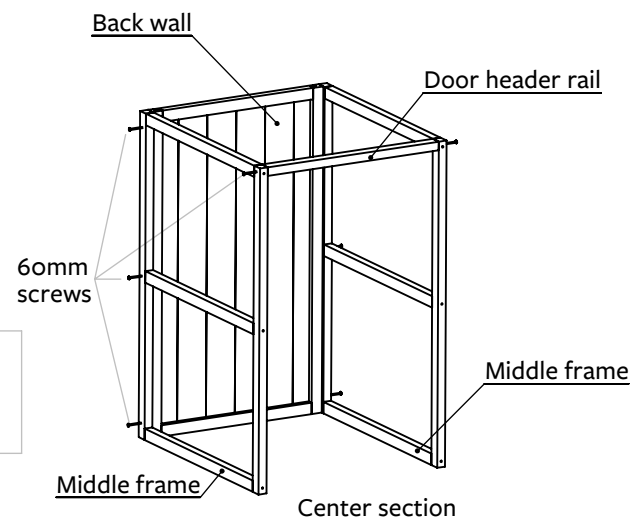
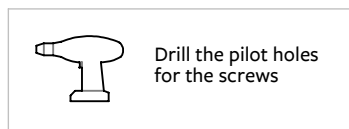
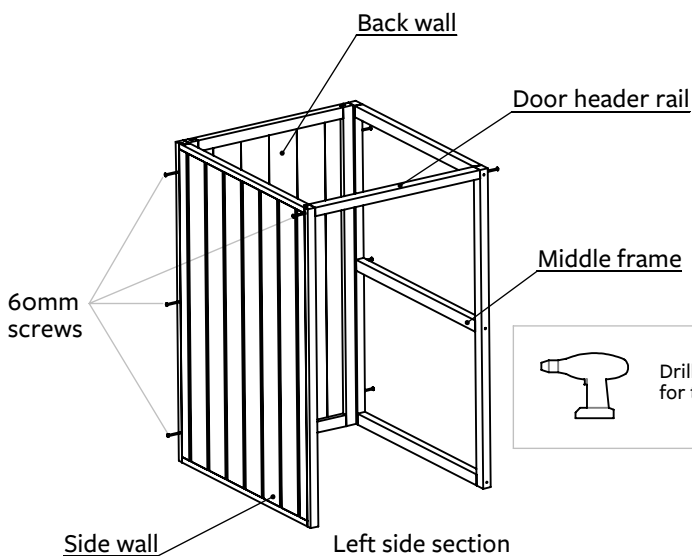

3. Connection of the Wall Panel Sections

Secure the center section between right and left hand wall sections as shown on drawings using 16 x 50mm screws. The metal rail connect with 25mm screws.

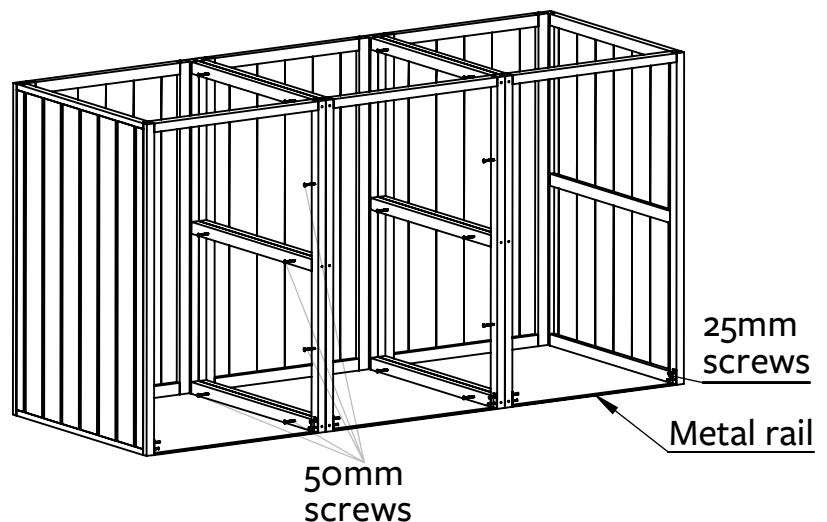
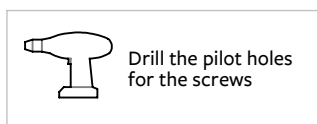

4. Doors

Position a tower bolt at the top of the each door and their catch plates on the middle frame as shown. Ensure the bolts align with the catch plates so that the bolts fits in the catch plate when in the locked position. Secure each bolt using 4 x 20mm screws and 2 x 20mm screws for each catch plate.

Secure two hinges to the each door using 3 x 30mm screws per hinge. Position the doors on the place and mark the right hinge position on the side wall front frames. Open the doors and fix the hinges to the side wall front frames using 3 x 30mm screws per hinge.

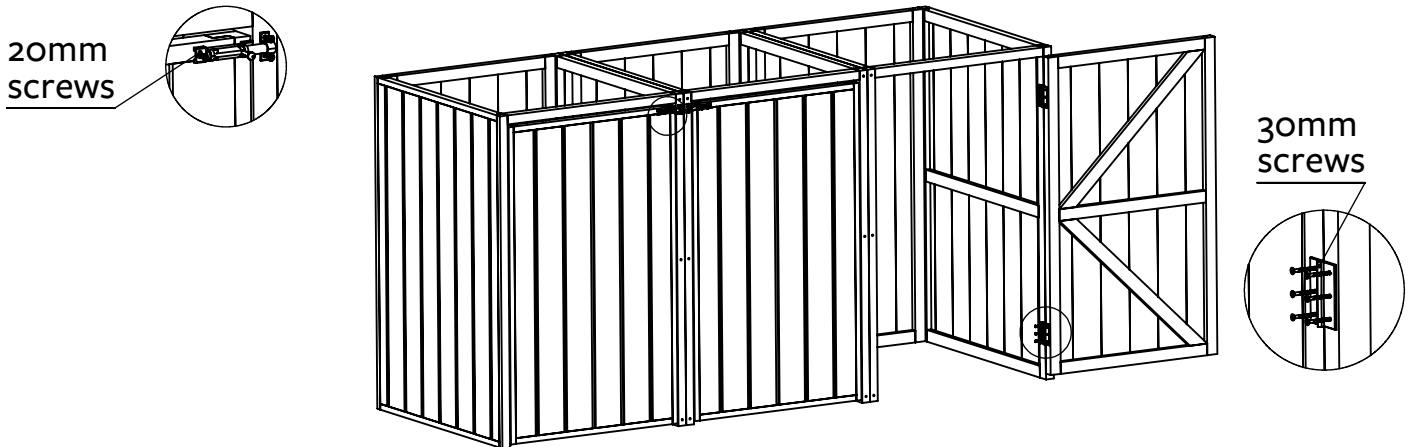

5. Lids

Place three lids on to the body of the assembly and at the back attach two hinges per lid and fix with the 6x20mm screws per hinge.

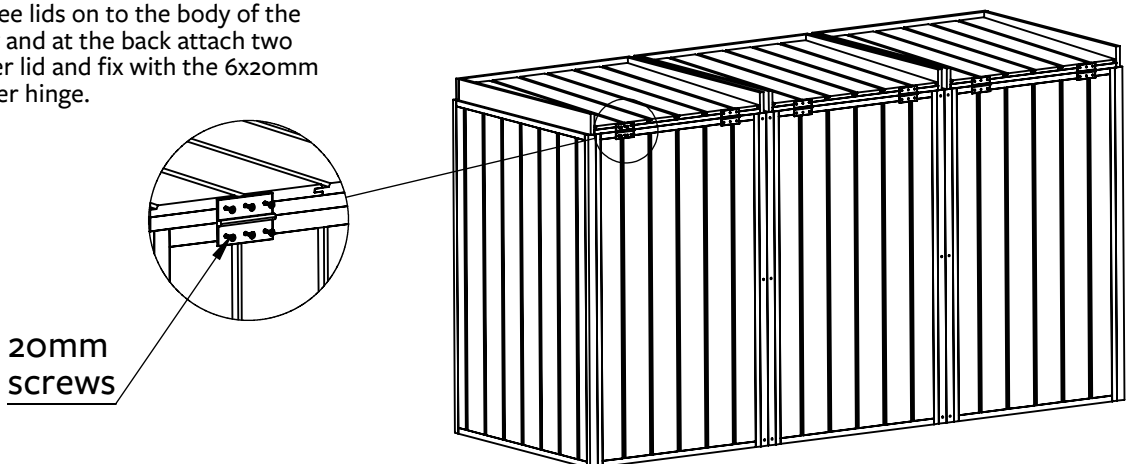

6. Handles, chains

Attach the handles to the front of the lids using 4x20mm screws per handle. Attach one chain to each lid. Screw through the end link of each chain into the side of the lid frame as shown using 1 x 25mm round head screw.

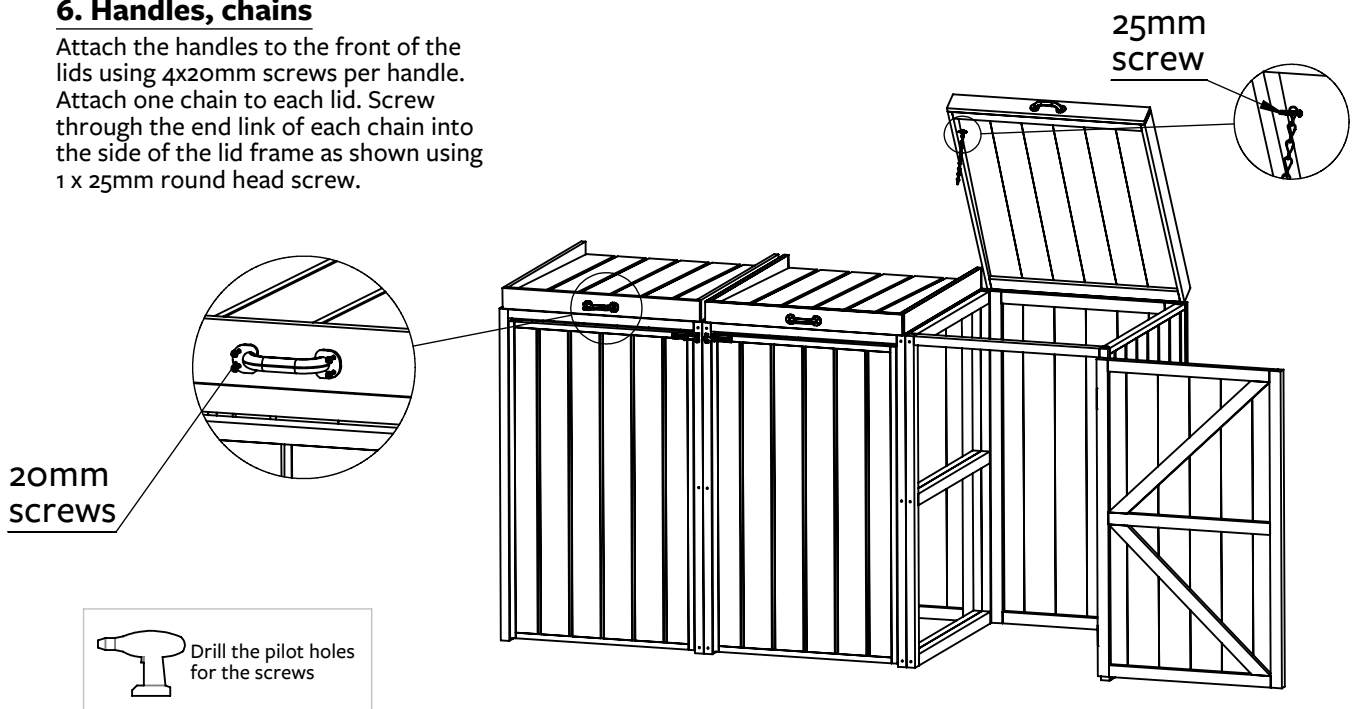

Drill the pilot holes for the screws

